

Product Catalogue

At EcoFlow, we provide innovative and reliable solutions to meet your power needs. Our energy solutions offer clean power, while our smart devices offer unparalleled convenience.



CONTENTS

About EcoFlow	01
Our Technology	04
Solar Generators	06
Portable Power Stations (RIVER 2 and DELTA Series)	
EcoFlow Solar Panels	
Smart Devices & Ecosystem	36
EcoFlow BLADE	
EcoFlow WAVE 2	
EcoFlow GLACIER	
EcoFlow Smart Generator (Dual Fuel)	
EcoFlow Smart Home Panel	
EcoFlow Solar Tracker	
EcoFlow Single Axis Solar Tracker	
Solutions	46
EcoFlow Power Kits	
EcoFlow PowerOcean	

About EcoFlow

EcoFlow is a leading eco-friendly energy solutions company with the vision to power a new world. Since its founding in 2017, EcoFlow aims to become a reliable and trusted energy companion for individuals and families across the world, providing accessible and renewable power solutions at home, outdoors, and in mobile spaces.

Today, with operational headquarters located in the USA, Germany, and Japan, EcoFlow has empowered more than 2 million users in over 100 markets worldwide.



EcoFlow's Mission

Our Vision:

The world is at the intersection of major paradigm shifts toward artificial intelligence, electrification, and new energy. 'POWER A NEW WORLD' is a call to the future amid these changes.

EcoFlow believes in an aspirational, eco-friendly, and technologically driven future that every individual can own. EcoFlow's meaningfully innovative power solutions are designed to bring a positive impact on individuals, families and society at large.

Our Mission:

To lead as a reliable and trusted energy companion for families and individuals around the world. We aim to empower our users with meaningful innovations, helping people across the world to live, dream, and explore without limits.

Our Awards



Applications

Home Backup



Camping



Events



Boating



Remote Working



Construction



Health Care



Filmmaking



Off-grid



Our Technology

X-Boost

X-Boost is EcoFlow's proprietary tech that allows you to power appliances with a higher-rated power than your EcoFlow portable power station. X-Boost features an intelligent voltage control that marginally reduces voltage, allowing you to power devices with a lower-rated inverter, giving you more for less.



X-Stream (Patented)

EcoFlow's patented X-Stream technology delivers market-leading recharging speeds. Using a built-in smart inverter, EcoFlow portable power stations can recharge from 0% to 100% in as quick as 1 hour*.



*for RIVER 2 and RIVER 2 Max

Battery Management System

EcoFlow's BMS precisely measures real-time voltage, current, and temperature and conditions the battery for the best performance with an intelligent algorithm.



EPS

When the portable power station is plugged into the wall, any electronics connected to it are powered from the grid and not its battery (bypass mode). When power from the grid stops, as in a blackout, the power station automatically switches to battery power within 30ms.

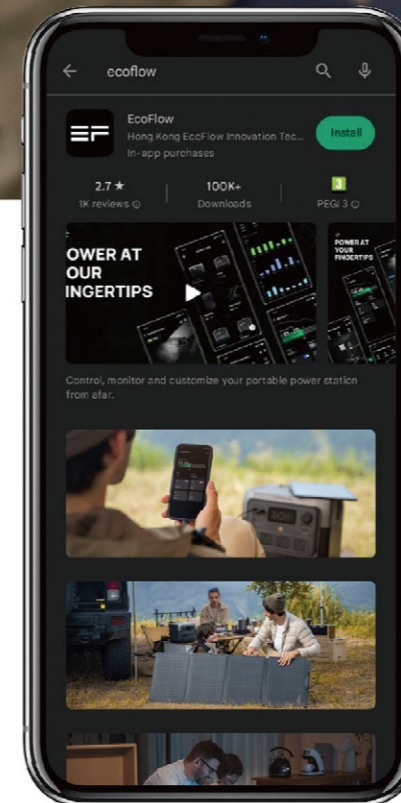

EcoFlow App

Q EcoFlow

In this wireless world, the ability to control devices remotely is a given. With the EcoFlow app, you can pair with your EcoFlow products and control everything from the palm of your hand.



Solar Generators

Perfect for camping, motorhomes, boats, or as an emergency home backup if you lose power.



Portable Power Stations
RIVER 2 Series

AC Output:
300W to 800W

Capacity:
256Wh to 768Wh



RIVER 2

256Wh of Grab-and-Go Power

RIVER 2 beats the industry standard for blazing charging speeds, long-lasting LFP battery chemistry with over 3000+ cycles, and a 30% lighter weight than the previous generation. Experience peace of mind with a 5-year warranty. That's one of the most extended guarantees in the industry.



#LFP battery





RIVER 2 Max

Take Home Comforts Anywhere

RIVER 2 Max is a cut above the rest. With LFP battery chemistry, it's safe, durable, and highly efficient. And, with 4 ways to charge, including solar, you can recharge off-grid in a matter of hours.





RIVER 2 Pro

Unleash a 'RIVER' of Power

A portable power station with TÜV Rheinland certification, RIVER 2 Pro is an ideal companion for your caravan or home. Crank it up to 1600W with X-Boost mode for running 80% of high-wattage appliances. And, with a 30 ms switchover time and the EcoFlow app to remotely control and monitor—power security just levelled up!



RIVER 2 Series Comparison



	RIVER 2	RIVER 2 Max	RIVER 2 Pro
Capacity	256Wh	512Wh	768Wh
AC Output	1 outlet, 300W	2 outlets, 500W	3 outlets, 800W
AC Charging	0-100% in 60 mins (360W Max)	0-100% in 60 mins (660W Max)	0-100% in 70 mins (940W Max)
Max Device(s) power supported by X-Boost	600W	1000W	1600W
Total Outlets	5	9	10
Solar Input	110W, 11-30V 8A Max	220W, 11-50V 13A Max	220W, 11-50V 13A Max
Battery	LFP chemistry 3000 cycles to 80% capacity	LFP chemistry 3000 cycles to 80% capacity	LFP chemistry 3000 cycles to 80% capacity
App	✓	✓	✓
Dimensions	24.5 × 21.5 × 14.2 cm	27 × 26 × 19.6 cm	27 × 26 × 22.6 cm
Weight	3.5 kg	6 kg	7.8 kg

Run Times



	RIVER 2	RIVER 2 Max	RIVER 2 Pro
Phone 11Wh (Type-C)	19 times	38 times	57 times
Drone 40Wh (Type-C)	4 times	10 times	15 times
Laptop 60Wh (Type-C)	3.4 times	6.8 times	10.2 times
Light 10W (DC)	20 hr	40 hr	60 hr
Speaker 10W (AC)	7.9 hr	15.8 hr	23.7 hr
CPAP 40W (AC)	4.6 hr	9.2 hr	13.8 hr
Car Fridge 60W (DC)	3.1-6.2 hr	6.2-12.4 hr	9.3-18.6 hr
50" TV 110W (AC)	1.85 hr	3.7 hr	5.6 hr
Electric blanket 120W (AC)	1.7 hr	3.4 hr	6.1 hr
Refrigerator 120W (AC)	1.7-3.4 hr	3.4-6.8 hr	6.1-12.2 hr

*The appliance run times and durations of use provided in the table above have been calculated with an AC Output. The data is for reference only. Please conduct tests to confirm the actual run time of your appliances.

Charging Times



RIVER 2



RIVER 2 Max



RIVER 2 Pro



AC Wall Outlet

1 hr (360W)

1 hr (660W)

1.2 hr (940W)



Solar Panel

2.3 hr (110W x 1)

3.2 hr (160W x 1)

3.5 hr (220W x 1)



Car Charger

3 hr

6 hr

9 hr

*The data above is for reference only

Solar Charging Recommendations

RIVER 2

RIVER 2 Max

RIVER 2 Pro

Max Solar Input

110W

220W

220W

Light Use
When Portability Matters

2.3 hr (110W x 1)

3.2 hr (160W x 1)

4.8 hr (160W x 1)

Heavy Use
When Quality Time Matters

2.3 hr (220W x 1)

3.5 hr (220W x 1)

*The data above is for reference only

Portable Power Stations DELTA Series

AC Output:

1800W to 3600W

Capacity:

1024Wh to 3600Wh



DELTA Series Comparison



DELTA 2



DELTA Max 1600



DELTA Max 2000



DELTA 2 Max



DELTA Pro

Capacity	1024Wh	1612Wh	2016Wh	2048Wh	3600Wh
Extra Battery	Supports 1 × DELTA 2 Extra Battery or 1 × DELTA Max Extra Battery	Supports up to 2 × DELTA Max Smart Extra Batteries	Supports up to 2 × DELTA Max Smart Extra Batteries	Supports up to 2 × DELTA 2 Max Smart Extra Batteries	Supports up to 2 × DELTA Pro Smart Extra Batteries
AC Output	4 outlets, 1800W	4 outlets, 2000W	4 outlets, 2400W	4 outlets, 2400W	4 outlets, 3600W
AC Charging	1200W Max, 80 mins fully charged	1600W Max, 1.6 hours fully charged	2000W Max, 1.6 hours fully charged	2300W Max, 81 mins fully charged	1800W Max, 2.7 hours fully charged
Max Device(s) power supported by X-Boost	2400W	2500W	3000W	3000W	4500W
Total Outlets	13	13	13	13	14
Solar Input	500W, 11-60V, 15A Max	800W, 11-100V, 13A Max	800W, 11-100V, 10A Max	1000W, 11V-60V, 15A Max	1600W, 11-150V, 15A Max
Battery	LFP chemistry 3000 cycles to 80% capacity	NCM chemistry 500 cycles to 80% capacity	NCM chemistry 800 cycles to 80% capacity	LFP chemistry 3000 cycles to 80% capacity	LFP chemistry 3500 cycles to 80% capacity
App	✓	✓			
Dimensions	40 × 21.1 × 28.1 cm	49.7 × 24.2 × 30.5 cm	49.7 × 24.2 × 30.5 cm	49.7 × 24.2 × 30.5 cm	63.5 × 28.4 × 42 cm
Weight	12 kg	22 kg	22 kg	23 kg	45 kg



DELTA 2

Not Just a Battery

With a 1800W output, DELTA 2 powers 90% of home appliances, even high-wattage ones up to 2400W with X-Boost mode. Run 13 essential devices simultaneously. A must-have for those who put power security and home comfort first.

DELTA Max (1600/2000)

Unleash Your Capacity

Backup your home during power outages with a DELTA Max portable power generator. With an expandable capacity that reaches up to 6kWh, dual charging, and the ability to power your home devices, you can stay powered on in any situation.

DELTA 2 Max

Power Every Day For 10 Years

With upgraded LFP battery chemistry, DELTA 2 Max is designed to offer reliable power for more than 10 years. With the industry's fastest charging speeds, DELTA 2 Max is ready for any situation, balancing off-grid with home power needs. Connect solar panels or integrate with EcoFlow PowerStream to reduce energy bills and cut energy waste.

DELTA Max Extra Battery

Double or triple the capacity of DELTA Max to 4032Wh or 6048Wh, to keep those key appliances running longer. DELTA Max's Smart Extra Battery benefits from all the charging methods DELTA Max has, allowing you to charge anytime.

Capacity: 2016Wh

Battery: NCM chemistry, 800 cycles to 80% capacity

Weight: 18 kg

Dimensions : 46.4 x 23.5 x 28.3 cm





DELTA Pro

Live Without Limits

The EcoFlow DELTA Pro is the world's first portable home battery with an expandable ecosystem for home backup, smart energy management, lower energy bills, and more.

DELTA Pro Extra Battery

Double or triple the capacity of DELTA Pro to 7.2kWh or 10.8kWh, to keep those key appliances running longer. DELTA Pro's Smart Extra Battery benefits from all the charging methods DELTA Pro has, allowing you to charge anytime.

Capacity: 3600Wh

Battery: LFP chemistry, 3500 cycles to 80% capacity

Weight: 38 kg

Dimensions: 63.5 x 28.5 x 41.6 cm



Run Times



	DELTA 2	DELTA Max (1600)	DELTA Max (2000)	DELTA 2 Max	DELTA Pro
Phone 11Wh (Type-C)	89 times	140 times	175 times	153 times	313 times
Camera 16Wh (USB)	60 times	94 times	118 times	85 times	210 times
Drone 40Wh (Type-C)	25 times	38 times	48 times	30 times	86 times
Laptop 60Wh (Type-C)	16 times	26 times	32 times	25 times	57 times
WiFi router 10W (AC)	31 hr	48 hr	60 hr	65 hr	108 hr
CPAP 40W (AC)	16 hr	22 hr	34 hr	40 hr	50 hr
50" TV 110W (AC)	7.9 hr	12 hr	15 hr	16 hr	27 hr
Refrigerator 120W (AC)	7-14 hr	11-22 hr	14-28 hr	14-28 hr	24-28 hr
Electric hammer 1260W (AC)	0.6 hr	1.2 hr	1.5 hr	1.3 hr	2.5 hr
Circular Saw 1400W (AC)	0.6 hr	1 hr	1.3 hr	1.2 hr	2.3 hr

*The appliance run times and durations of use provided in the table above have been calculated with an AC Output. The data is for reference only. Please conduct tests to confirm actual run time of your appliances.

Charging Times



	DELTA 2	DELTA Max (1600)	DELTA Max (2000)	DELTA 2 Max	DELTA Pro
AC Wall Outlet	1.3 hr (1200W)	1.6 hr (1600W)	1.6 hr (2000W)	1.35 hr (2300W)	1.9 hr (2900W)
Solar Panel	2.6 hr (400W x 1)	4.0 hr (400W x 1)	5.0 hr (400W x 1)	2.3 hr (220W x 4)	9.0 hr (400W x 1)
Car Charger	11 hr	16.8 hr	21 hr	7 hr (12V/8A) 13.8 hr (24V/8A)	37.5 hr

*The data above is for reference only

Solar Charging Recommendations

	DELTA 2	DELTA Max (1600)	DELTA Max (2000)	DELTA 2 Max	DELTA Pro
Max Input	500W	800W	800W	1000W	1600W
Light Use When Portability Matters	4.7 hr (220W x 1)	10 hr (160W x 1)	9.1 hr (220W x 1)	5.1 hr (400W x 1)	9.0 hr (400W x 1)
Heavy Use When Quality Time Matters	2.6 hr (400W x 1)	2.0 hr (400W x 2)	2.5 hr (400W x 2)	2.6 hr (400W x 2)	3.0 hr (400W x 3)

*The data above is for reference only

EcoFlow Solar Panels

EcoFlow Solar Panels are expertly designed to offer users an efficient, reliable, and eco-friendly solution for charging power stations and smart devices. Our solar panels are made of premium, grade A monocrystalline cells that are 100% EL tested.

With both portable and mountable options, whether you're on a camping trip, an off-grid adventure, or simply need a reliable power source for your electronic devices, EcoFlow Solar Panels are the perfect solution.

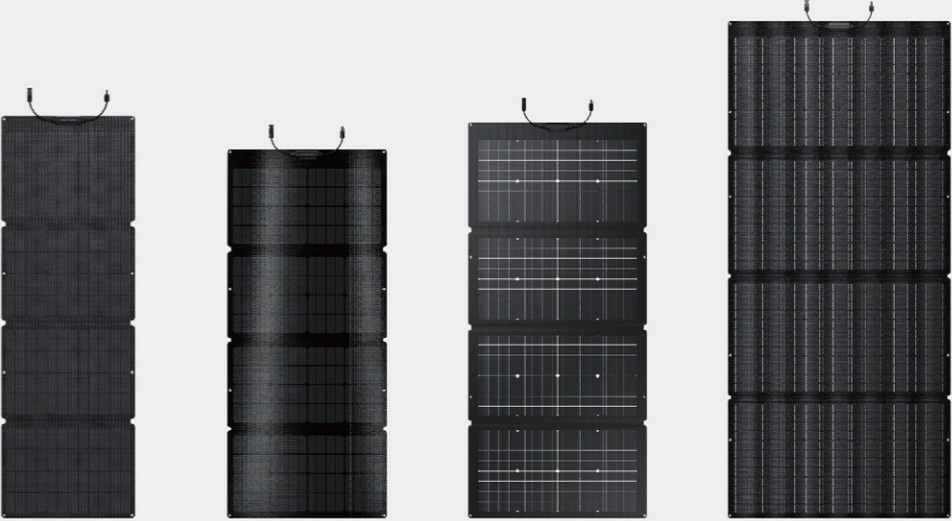

110W Portable Solar Panel 160W Portable Solar Panel 220W Bifacial Portable Solar Panel 400W Portable Solar Panel

TESTS & CERTIFICATIONS 



100W Flexible Solar Panel

TESTS & CERTIFICATIONS 



100W Rigid Solar Panel

TESTS & CERTIFICATIONS 

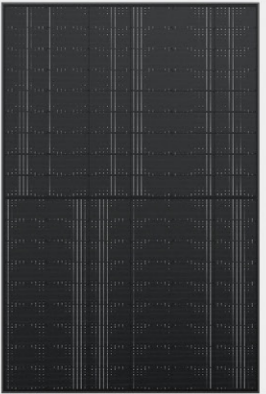

400W Rigid Solar Panel

TESTS & CERTIFICATIONS 

Portable Solar Panels

Our most versatile solar panels are compact and lightweight, making them ideal for almost any situation, including heading off-grid. Unfold, and prop up with the built-in stand in a matter of seconds to fast charge your portable power station while you camp or at home for blackout prep.



160W Portable Solar Panel

Rated Power: 160W ($\pm 5W$)
Waterproof Rating: IP68
Open Circuit Voltage: 21.4V
Weight: 5.6 kg
Short Circuit Current: 9.6A
Dimensions (unfolded): 159 x 68.5 x 2.5 cm
Efficiency: 21%-22%
Cell Type: Monocrystalline Silicon

110W Portable Solar Panel

Rated Power: 110W ($\pm 5W$)
Waterproof Rating: IP68
Open Circuit Voltage: 21.8V
Weight: 4 kg
Short Circuit Current: 6.5A
Dimensions(unfolded): 42 x 178.5 x 2.5 cm
Efficiency: 22.8%
Cell Type: Monocrystalline Silicon



220W Bifacial Portable Solar Panel

Rated Power: 220W (± 5 W) Front Side, 155W (± 5 W) Rear Side
Waterproof Rating: IP68
Open Circuit Voltage: 21.8V
Solar Panel Weight: 19 kg
Short Circuit Current: 13A Front Side, 8.8A Rear Side
Dimensions (unfolded): 82 x 138.5 x 2.5 cm
Efficiency: 22%-23%
Cell Type: Monocrystalline Silicon



400W Portable Solar Panel

Rated Power: 400W (± 10 W)
Waterproof Rating: IP68
Open Circuit Voltage: 48V
Solar Panel Weight: 19 kg
Short Circuit Current: 11A
Dimensions: 236.5 x 105.8 x 2.5 cm
Efficiency: 22.6%
Cell Type: Monocrystalline Silicon

Rigid Solar Panels

Best suited for permanent mounting on the roofs of motorhomes, off-grid builds, and with our high 400W rigid panel, even homes. Made with monocrystalline cells, anodized aluminium frames, protective tempered glass, and a waterproof rating of IP68, rigid solar panels can last for years.



* Rated power is tested under Standard Test Conditions: 1000W/m2, AM1.5, 25°C

100W Rigid Solar Panel

Rated Power: 100W ($\pm 5W$)*
Waterproof Rating: IP68
Open Circuit Voltage: 20.3V
Solar Panel Weight: 6.2 kg

Short Circuit Current: 6.3A
Dimensions: 980 x 586 x 30 mm
Efficiency: 23%
Cell Type: Monocrystalline Silicon



* Rated power is tested under Standard Test Conditions: 1000W/m2, AM1.5, 25°C

400W Rigid Solar Panel

Rated Power: 400W ($\pm 12W$)*
Waterproof Rating: IP68
Open Circuit Voltage: 37.10V
Solar Panel Weight: 21.8 kg

Short Circuit Current: 13.79A
Dimensions: 1722 x 134 x 35 mm
Efficiency: 23%
Cell Type: Monocrystalline Silicon

Flexible Solar Panels

These lightweight solar panels can be installed on any surface, including fabric roofs such as tents or awnings. Its flexible design caters to curved roofs and can be fixed seamlessly to motorhomes and boats. Without a bulky frame and pre-drilled eyelets around the perimeter, our flexible solar panels are extremely easy to mount and move at any time.



* Rated power is tested under Standard Test Conditions: 1000W/m2, AM1.5, 25°C

100W Flexible Solar Panel

Rated Power: 100W ($\pm 5W$)*
Waterproof Rating: IP68
Open Circuit Voltage: 20.3V (Vmp 17.1V)
Solar Panel Weight: 2.3 kg
Short Circuit Current: 6.3A
Dimensions: 1055 x 612 x 25 mm
Efficiency: 23%
Cell Type: Monocrystalline Silicon

Smart Devices & Ecosystem



EcoFlow BLADE

We're revolutionising lawn care by going beyond the mower. BLADE not only offers hassle-free, cutting-edge lawn mowing, but combines AI with a handy never-seen-before sweeping tool that cleans your garden of leaves, twigs and other debris. Just let it mow so you focus on the important stuff.



Automatic Lawn Sweeping.

A perfectly manicured lawn is more than just about the cut, so BLADE comes with an add-on kit that clears your garden of leaves and other debris.

No Wiring With A Virtual Boundary.

We're all about making work light, so you can set a virtual boundary right from the EcoFlow app, without the need for any wiring. Once BLADE's set to work, it'll auto-plan a route, cutting your lawn just right. Every single time.

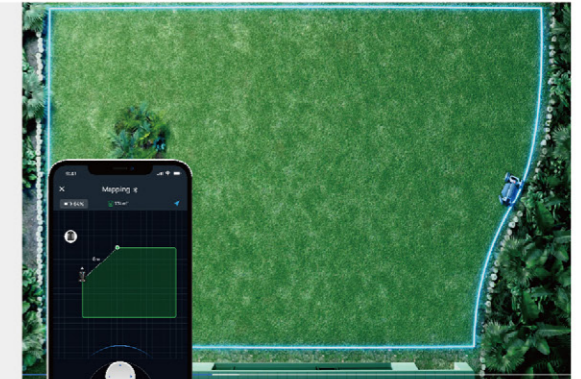

Smart Obstacle Avoidance.

With cutting-edge X-Vision technology, BLADE avoids obstacles by quickly re-routing. You'll never get stuck or miss a cut. That's unlike any mower on the market.



Net Weight: 16.2 kg
Dimensions: 660 x 440 x 310 mm
Recharge Time: 130 min
Waterproof Level: IPX5

Cutting Height: 20-76 mm
Cutting Width: 260 mm
Climbing Ability: 27°
Fully-Charged Working Time: 240 min

EcoFlow WAVE 2

EcoFlow WAVE 2 is the world's first wireless portable AC with a heater. Enjoy cooling and heating for outdoor comfort with the most powerful and compact portable AC on the market.



Fastest Cooling and Heating

The world's first wireless portable AC with a heater. EcoFlow's tailor-made compressor enables WAVE 2 to provide 5100 BTUs of cooling and 6100 BTUs of heating.

Long 8-hour Run Time With an Add-on Battery*

With its swappable add-on battery, WAVE 2 can operate wirelessly for up to 8 hours and can be fast charged using AC, solar, cars, or power stations.

*The Add-on Battery is sold separately as an optional accessory.



44 db: Sleep Peacefully with App Control

With EcoFlow's advanced software algorithm, the WAVE 2 offers multiple modes and app control. It runs quietly (44 dB) in Sleep Mode and up to 8 hours in Eco Mode.



Net Weight: Approximately 14.5 kg
 Dimensions: 518 x 297 x 336 mm
 Cooling Area: ≤ 10 m² / 107.6 ft²
 Cooling Capacity: 1500W / 5100BTU
 Rated Cooling Input Power (AC/DC): 550W / 495W

Heating Capacity: 1800W / 6100BTU
 Rated Heating Input Power (AC/DC): 600W / 540W
 AC Input: 100-240V, 50/60Hz, 820W Max
 Solar Charging Input: 11-60V, 13A, 400W Max
 Car Charging Input: 96W/192W (12/24V, 8A Max)

EcoFlow GLACIER

EcoFlow GLACIER is the world's first 3-in-1 portable fridge, freezer, and ice maker. Enjoy ice-cold drinks and fresh food when you're on the road, boating, camping, or even off-grid.



Industry's First Integrated Ice Maker.

Equipped with a powerful 120W compressor, GLACIER makes 18 solid ice cubes in 12 minutes. For all the spine-tingling moments along your journey, spice them up with chilled sodas.

Dual Zone, Dual Control.

Equipped with a removable divider separating it into two zones, and independent temperature control, both sections can refrigerate and freeze from 10°C to -25°C.

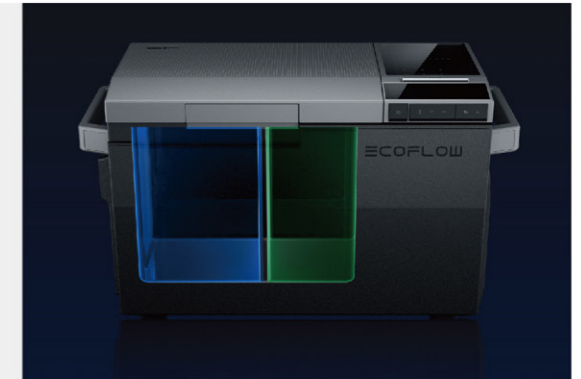

Cooling for up to 40 Hours Wire-free.

Designed for absolute portability, power GLACIER using the Plug-in Battery, without messy, limiting cables. With a large battery capacity of 298Wh, savour up to 40 hours of easy access to frozen meals, fresh fruit, and ice-cold beverages.



Net Weight: 23 kg
Dimensions (wheels and handles not included):
776 x 385 x 445 mm
Refrigeration Power Rating: 120W
Refrigerant type/Amount: R600a, 32 g

AC Input: 100-240V, 50/60Hz, 180W
Solar Charging Input: 240W (11-60V, 13A Max)
Car Charging Input: 96W/192W (12/24V, 10A Max)
Battery Pack Power: 100W (USB-C)

EcoFlow Smart Generator (Dual Fuel)

The EcoFlow Smart Generator is the ultimate backup power solution to serve as an addition to your DELTA Pro, DELTA Max, or Power Kits. It's now dual-fuel compatible, with both gas and LPG support. It has a smart app to remotely control and monitor, and 5 alert methods; making it more efficient and easier to use than ever before!



EcoFlow Solar Tracker

The EcoFlow Solar Tracker is a unique solar racking-mounting device that offers higher efficiency than its standard model counterparts. It's the first mobile solar tracker on the market that is easy to install and move anytime.



EcoFlow Smart Home Panel

The EcoFlow Smart Home Panel is the heart of the DELTA Pro home battery ecosystem. It integrates up to two DELTA Pro units with 10 home circuits. Each DELTA Pro can be connected with Extra Batteries, solar panels, or Smart Generators, giving you uninterrupted power during blackouts, smart energy management for your critical loads, and lower energy bills.



EcoFlow Single Axis Solar Tracker

The Single Axis Solar Tracker is a rack-mounting system that when combined with a rigid solar panel, is 60% more efficient at collecting solar energy. With an 80° auto-adjusting angle, our Single Axis Solar Tracker follows the sun, maximising the solar panel's exposure to the sun. It smoothly attaches to a variety of balconies and verandas and easily unclips to move elsewhere.



EcoFlow Power Kits

EcoFlow Power Kits are the world's first all-in-one, plug & play power solutions designed specifically for caravans and off-grid builds. Combine up to three 5kWh EcoFlow LFP batteries with an EcoFlow Power Hub, solar panels, and much more.



Key Components



EcoFlow Power Hub

Power Hub is the heart of your Power Kit. It does the job of 5 components, including 2 MPPT solar charge controllers, a DC-DC battery charger with MPPT, a DC-DC step-down converter, and an inverter charger. Save valuable space and setup time in your caravan or off-grid build.



EcoFlow 2kWh/5kWh LFP Batteries

Power Kits use EcoFlow's 2kWh or 5kWh LFP batteries, expandable to 15kWh to match your consumption needs. They're stackable with built-in BMS and auto-heating for cold environments too. Save space, and stay safe.



EcoFlow AC/DC Smart Distribution Panel

Link your appliances with the Smart Distribution Panel's 6 AC positions and 12 DC positions.



EcoFlow Power Kits Console / EcoFlow App

Control, monitor, and view your power consumption using the Console or from the comfort of your phone with the EcoFlow app.



EcoFlow Solar Panels

Charge your batteries with EcoFlow's line of solar panels. Supporting up to 4800W of solar input, you can pick and choose the amount of solar you need to charge anywhere.

EcoFlow Power Kits

Key Applications

Vans / Caravans / Trailers



Compact

Save space in your motorhome. Less components. Thinner wires.



Simple Set Up and Expandable

Capacities from 2-15kWh. Convenient plug and play set up.



Multiple Charging Methods

Stop for shore power less often with solar and alternator charging

Off-grid Builds / Tiny Houses



48V System

Less heat transferred. Thinner wires. Higher efficiency.



Fully Expandable

Get your setup right with your choice of solar panels and batteries.



4800W Solar Input for Off-grid Living

Live with renewable energy. Power Hub allows a solar input of up to 4800W across three ports. Each supports up to 1600W solar input.



Key Features

Save Space

EcoFlow Power Hub combines two MPPT solar charge controllers, one battery charger with MPPT, one DC-DC step-down converter, and an inverter-charger. With fewer modules and thinner wires, this 48V system saves you space and installation hassle.

Charge Your Way

EcoFlow Power Kits support multiple charging methods that can be combined to charge with up to 6000W. Get plenty of solar power, use your alternator, plug in shore power, or even use an EcoFlow Smart Generator in an emergency.

Simple Set Up

The integrated EcoFlow Power Hub has a simple plug-and-play design, allowing you to expand and customise your kit faster than any other power solution on the market.

Safety First

With built-in BMS, each battery is protected from over-voltage and high current, all while balancing multiple battery cells. In addition, the system's 48V design is efficient and creates less heat offering a safer electrical system for your motorhome or off-grid build.



How It All Fits Together.

Vans / Caravans

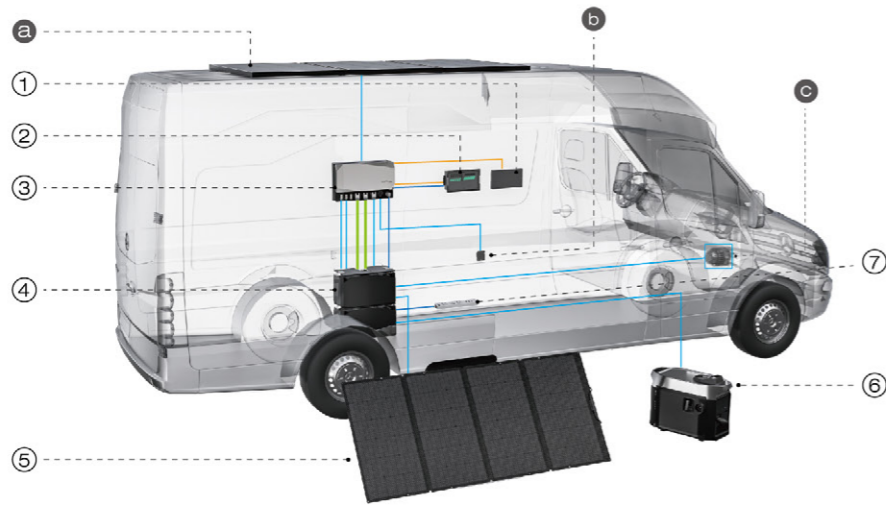

Off-grid Builds

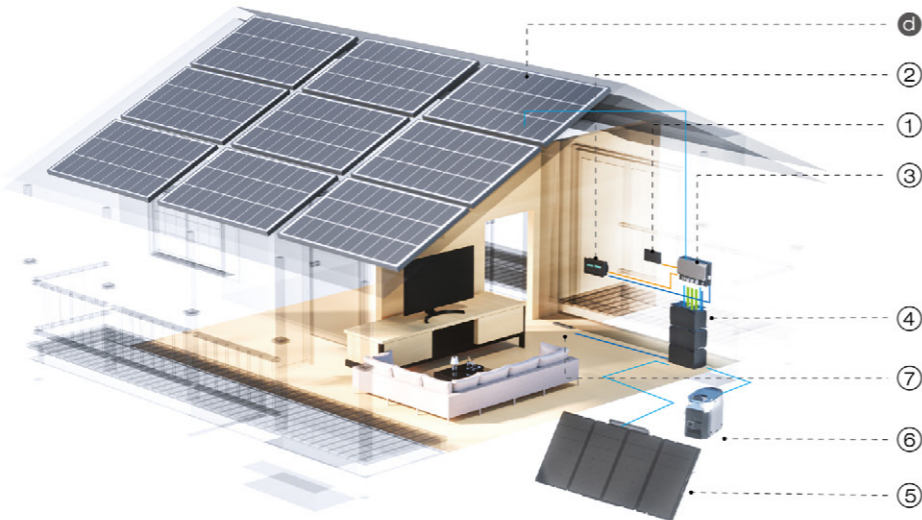

- ① EcoFlow Power Kits Console
- ② EcoFlow AC/DC Smart Distribution Panel
- ③ EcoFlow Power Hub
- ④ EcoFlow 5kWh LFP Battery
- ⑤ EcoFlow 400W Portable Solar Panel
- ⑥ EcoFlow Smart Generator
- ⑦ Power Strip
- a EcoFlow 100W Rigid Solar Panel
- b Shore Power Inlet
- c Alternator Charging
- d EcoFlow 400W Rigid Solar Panel

Specs

Power Hub

Net Weight	14 kg
Dimensions	30 x 48 x 14 cm
Bluetooth	Supported
Wi-Fi	Supported
Testing and Certifications	CE, UL, FCC, UKCA, E-Mark, RCM, TELEC, KCC, ICES, EMC Class A

OUTPUT

AC Output	Pure sine wave, 3600W (surge 7200W), 220-240V, 50/60Hz
DC Output	13.6V 70A, 1000W Max or 26.4V 60A 1600W Max

INPUT

Total Input	Max Power: 6000W
AC Main Input (Frequency)	220-240V, 50/60Hz, 3000W Max, 15A Max Supported by X-Stream Fast Charging
Alternator Input 1/2/3	13-60V 30A (Input 1 : 60A), Max Power: 1600W each
PV Input 1/2/3	15-60V 30A, Max Power: 1600W each
Operating Temperature	-25°C-60°C
Warranty	5 years

AC/DC Smart Distribution Panel

AC Main Input	220-240V, Max. 30A
DC Main Input	10-30V, Max. 70A
AC Output	6 AC positions (1/2: 20A, 3/4/5/6: 10A), 220-240V
DC Output	12 fused DC positions (6 smart control circuits), Max. 20A
Operating Temperature	-25°C-60°C
Dimensions	21 x 35.4 x 9.8 cm
Net Weight	2.6 kg
Protection Level	IP21
Testing and Certifications	CE, UL, FCC, UKCA, E-Mark, RCM, TELEC, KCC, ICES, EMC Class B
Warranty	5 years

Power Kits Console

Touch Screen (Diagonal)	15.4 x 8.6 cm
Power Supply Voltage	12V DC
Operating Temperature	-20°C-50°C
Dimensions	11.3 x 20.5 x 2.2 cm
Net Weight	0.45 kg
Tests and Certifications	UL, FCC, CE, E-Mark, UKCA, UN38.3, RCM, PSE, EMC Class B
Warranty	5 years

2kWh LFP Battery

Capacity	51.2V, 40Ah (2048Wh)
Net Weight	17.1 kg
Dimensions	28.4 x 34.8 x 19.8 cm
Cycle Life	3000 cycles to 80% capacity
Cell Chemistry	LFP (Lithium Iron Phosphate)
Protection Level	IP54
Operating Temperature	-20°C-50°C
Battery Management	Auto-heating and advanced BMS (built-in)
Tests and Certifications	UL, FCC, CE, E-Mark, UKCA, UN38.3, RCM, PSE, EMC Class B
Warranty	5 years

5kWh LFP Battery

Capacity	51.2V, 100Ah (5120Wh)
Net Weight	40.6 kg
Dimensions	30 x 50 x 26 cm
Cycle Life	3500 cycles to 80% capacity
Cell Chemistry	LFP (Lithium Iron Phosphate)
Protection Level	IP54
Operating Temperature	-20°C-50°C
Battery Management	Auto-heating and advanced BMS (built-in)
Tests and Certifications	UL, FCC, CE, E-Mark, UKCA, UN38.3, RCM, PSE, EMC Class B
Warranty	5 years

EcoFlow PowerOcean

Home Solar Battery Solution

Discover the limitless potential of clean energy with PowerOcean, the innovative battery solution that seamlessly integrates with your existing solar system, delivering enhanced self-sufficiency and savings.



Flexible investment



Safe and Reliable



15 Year Warranty



Outage backup supported





Contact Us:

Ecobat Battery, 36a Vanguard Way,
Battlefield Enterprise Park, Shrewsbury,
Shropshire, SY1 3TG, UK

0333 577 6690

For sales enquiries email is.info@ecobat.com